

HOT BOTTOM[®]
WOLLOB LOH

MODEL E-300 HOT BOTTOM

Physical Dimensions

Length 86"
Width 50"
Height 71"

Tank Capacity, gallons

maximum 300
nominal 240

Weight, pounds

empty 1,800

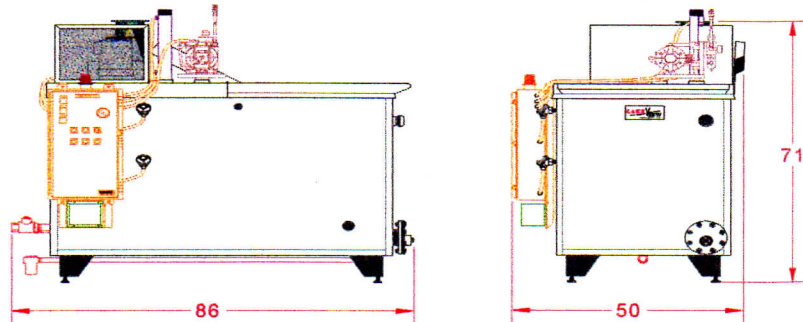

Evaporation Rate E-300 Hot Bottom -- 32 gallons per hour

(Evaporation rate varies with the nature of the waste solution and input of BTUs.)

LAKEVIEW E-SERIES WASTEWATER EVAPORATOR

POWER REQUIREMENTS

STEAM REQUIREMENTS -- 140 psi, requires 320# steam/hr,
10 bhp. Steam below 100 psi will result in reduced evaporation rate.

ELECTRICAL REQUIREMENTS -- 480v, 3ph, 6 amps @ 480v

COMPRESSED AIR -- 100 psi maximum, 8 scfm maximum for filling

STANDARD SPECIFICATIONS/FEATURES

Construction -- stainless steel for all wetted parts

Heat exchanger -- 3/8" grade 316L stainless steel, 150 psi maximum
pressure, A.S.M.E. Section VIII specifications, "U" stamped

Insulation -- 2" foil backed, 850°F, .30 conductivity, .043 SI units

Exhaust blower housing -- heavy gauge, tig welded stainless steel

Impeller -- self-cleaning backward inclined radial blade design

Stack connection -- 10" I.D. flanged

Fluid transfer pump - air operated diaphragm pump, 1/2" FPT

Blower motor -- 1-1/2 hp, 3ph, 1725 rpm

Control panel -- NEMA 4, industrial duty

Fluid level control -- float actuated ball valve

Fluid level sensors -- float actuated microswitches, high/low level

Coalescing filter -- framed galvanized steel mesh at blower inlet

Clean out -- 4" flange with eccentric reducer at 2" FPT

Weir -- built in for easy skimming of floating oils

Belt driven blower -- eliminates transference of vibration and heat

Pillow block bearings -- heavy duty, greasable for long life

Steam trap - 1" NPT trap with strainer on condensate line

Ball valve - 1-1/2" NPT valve on steam inlet to heat exchanger

OPTIONAL FEATURES

Special Tank Construction

Exhaust Stacks

Remote Fluid Level Sensors

Overspray/Foam Control

Automation Package

Skimmer/Sludge Pump

Fluid temperature monitor

Modulating steam valve

STANDARD SAFETY FEATURES

Industrial safety disconnect at the unit

Air-cooled, counterweighted access lid

Safety circuitry and manual reset

Safety cage around hot moving parts

Redundant safety and level controls

WARRANTY

Five (5) year limited warranty on water vapor blower impeller, the most used part of the evaporator. It is indicative of the quality and durability built into the complete unit. The entire evaporator carries a two (2) year limited warranty. See *Terms and Conditions of Sale and/or Warranty Certificates*.

LAKEVIEW ENGINEERED PRODUCTS INC

2500 W Jefferson Blvd, Fort Wayne IN 46802

tel: 260-432-3479

fax: 260-432-6239

www.lakeviewengineered.com

info@lakeviewengineered.com

NOTE: Evaporators should not be used with fluids that have a boiling point lower than water, contain volatile organic compounds or contain flammable materials.

"Hot Bottom"® E-Series Wastewater Evaporator Steam Powered - standard features

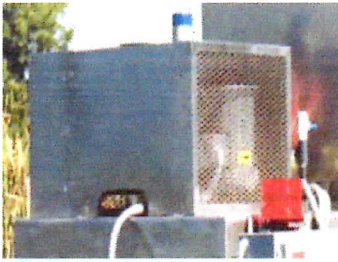

BLOWER GUARD

A safety cage surrounds the blower, blower motor, drive belt, and stack. This protects personnel from heated and moving parts.



CONTROL PANEL

Industrial duty panel with NEMA 4 rated enclosure. Operational controls include PLC controller, touch panel display and operator interface, heat exchanger temperature monitor, high/low level controls, tank fluid temperature sensor. Panel also utilizes a standard safety disconnect and red flashing warning beacon. Optional features may include-- digital read out and controls for overspray foam control, other NEMA ratings, remote panels, PLC automation.

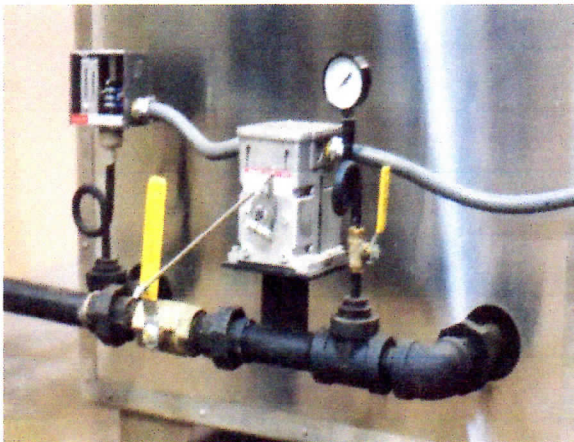

MODULATING STEAM VALVE

(recommended option on 200/300 units, standard on 600 and above) Installed in the steam line to control the volume of steam entering the steam chamber. This controls the heat input, the boiling, and the rate of evaporation within the unit. A strainer and steam trap on the condensate return line are provided. It can also be connected to the foam sensor to control foaming.



TANK

The entire unit, both interior and exterior, including all wetted internal parts are constructed of polished stainless steel. *Standard construction for all units* - 10 gauge (.140") walls, 3/8" plate floor, grade 316L stainless steel - offers excellent resistance to a wide range of corrosives and atmospheric exposures, high temperature strength. All sides are insulated with 2" fiberglass, 800°F rated. Alloy recommendation does not express or imply any warranties offered against material corrosion.

TANK CONSTRUCTION OPTIONS

- AL-6XN - 6% molybdenum super austenitic alloy for better chloride resistance without the expense of high nickel alloys.
- High nickel alloys - such as B-2, C-22, G-30, 20Cb-3 for a wide range of specific corrosive applications.
- Hastelloy C-276 - one of the more universally corrosion resistant alloys with excellent high chloride resistance and high temperature properties.

“Hot Bottom”® E-Series Wastewater Evaporator Steam Powered - standard features

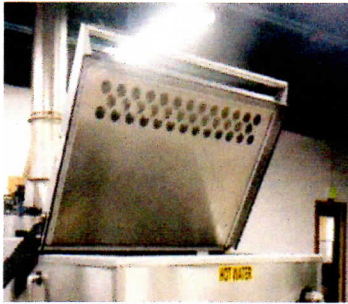

ACCESS LID

With exhaust air inlet - keeps lid cool to the touch. Lid is counter-weighted for operator safety.

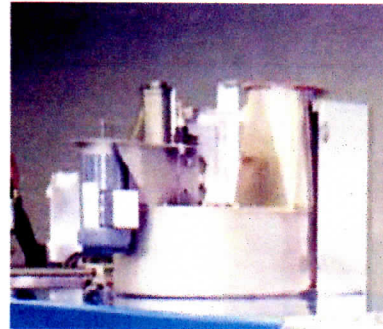

EXHAUST BLOWER

Designed specifically for evaporated vapor exhaust. This blower features an all stainless steel impeller with 5 year warranty. The impeller is self-cleaning backward inclined radial blade design that is electronically balanced for long continuous duty. It is belt driven with self-adjusting belt tensioner and

speed variable depending on model application. Two heavy duty, greasable pillow block bearings are utilized. The blower housing is all heavy gauge, tig welded, stainless steel construction for long life.



OIL SKIMMING WEIR

The oil skimming weir drains through a 2" port located at the right height for a barrel, or piping can be easily installed to direct the oil to a destination. The flat sloped bottom is designed for easy cleaning. No complicated bottom geometry to create cleaning problems.

CLEAN OUT PORT

The 4" NPT clean out port is located at the low point of the flat, sloped bottom for easy clean out. Both the oil skimming weir and clean out port may be connected to the skimmer sludge pump option with the 2" NPT reducer provided.

COALESCING FILTER

Located at the inlet to the water vapor exhaust blower to capture droplets that might be drawn up the stack. This is to minimize carry over of oils or particulate to the atmosphere. It is easily removed for cleaning or replacement when dirty. High density mist eliminator pads are also available for capturing 10 micro particulate.

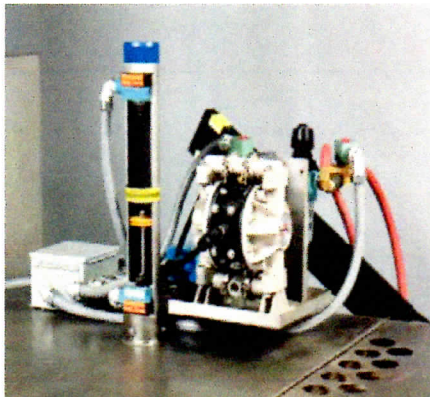

TRANSFER PUMP SYSTEM

Fluid level control is maintained by a float operated ball valve. The air operated transfer pump pumps fluid from a storage tank to the evaporator. When the fluid level is low in the evaporator, the pump forces fluid through the valve, as the fluid level rises the float ball rises on the surface of the fluid closing the valve. When the tank is full, the air pump stalls against the closed valve. Fluid level, by this method, is maintained at a constant level without larger volumes of wastewater introduced to the evaporator to cool and upset the fluid already in the tank. This results in efficient steady state operation.

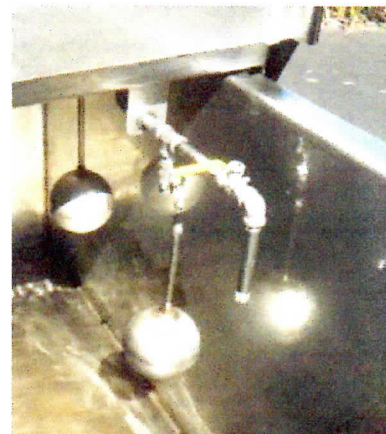

LEVEL CONTROLS

Redundancy level control is achieved by the use of a stainless steel lever-arm float valve assembly and a high/low level float switch assembly. The float valve assembly provides stable continuous feed into the evaporator, while the high/low level float switch monitors fluid level extremes and will shut down the burner, feed pump and indicate an alarm fault condition. Surface operating floats ignore foam and are not affected by fouling fluid concentrations or temperatures. The level switch also allows for fill control upon start up and auto restart.

"Hot Bottom"® E-Series Wastewater Evaporator Steam Powered - additional options



EXHAUST STACK

(recommended) Single walled stack used to exhaust water vapor to the atmosphere. Stainless steel stacks bolt together in five (5) foot sections with die cut gaskets.



OVERSPRAY FOAM CONTROL SYSTEM

(optional) Electric operated centrifugal pump that recirculates fluid from the evaporator and sprays it over the surface of the liquid waste. This helps to break up surface tension and allows the water to evaporate through any surface film. It also exposes more surface area to the air being pulled across the surface of the fluid assisting in the evaporation rate. Foam sensor

operates in the area above the normal operating fluid level and detects foaming conditions as they occur in the tank. This sensor then activates the overspray system. All components, pump, strainers, nozzles, valves, piping, and controls are included. 316 stainless steel for all wetted parts.

HOLDING TANK

HDPE, polypropylene, steel, or stainless steel. Many standard and custom engineered designs and sizes available. Connections, sight glass, manways, control interface, strainers, skimmers, and valves to suit requirements.

ANTI-FOAM DISPENSER

The chemical feed pump will automatically add the anti-foam agent to the waste solution in the evaporator. It operates in conjunction with a foam sensor that detects the presence of foam in the space above the normal operating fluid level in the evaporator tank.

ODOR CONTROL

A pneumatic dispenser releases an atomized chemical adsorbent from a strategic location into the evaporator air stream. Calibrated metering and available electric timer controls allow for tailoring to specific requirements.

SPECIAL APPLICATION, PLC CONTROLS

Remote operating controls or remote telemetry. Consult factory for special requirements or specific types.

REMOTE TANK SENSING SYSTEM

The feed tank that supplies the evaporator also works as a settling tank and an oil separator tank. Pumping separated sludge or oil to the evaporator will reduce overall efficiencies and require more operator and maintenance time. 1) The feed tank can be set up with sensors to determine oil and sludge layers and permit pumping only aqueous wastes to the evaporator. 2) The feed tank can be set up with level controls to determine presence of fluid and shut down or restart the evaporator according to demand.

PUMP DIAPHRAGMS

Standard transfer pump diaphragm is Santoprene. Other available pumps include Neoprene, Buna N, Viton, T.F.E. (Teflon) with urethane, E.P.R., and Polyurethane.



SKIMMER SLUDGE PUMP SYSTEM

(optional) Transfer and removal of skimmed oils and evaporator residue. Air operated diaphragm pump, 2" NPT, plumbed into clean out and oil skimming weir, all piping and valves for easy operation. Available as 1) aluminum housing, black iron pipe and bronze ball valves; 2) cast iron housing, black iron pipe and stainless ball valves; or 3) stainless steel housing, pipe and ball valves. 1" NPT pumps available for light duty applications. Manual and automated systems available.



REMOTE FLUID LEVEL SENSOR AND CONTROLS

(optional) Adjustable remote level float switch can be tether mounted in any type of waste-water storage vessel and connects to the evaporator control circuit to shut down the evaporator when wastewater supply is depleted and then restart the evaporator when the wastewater supply is replenished. This option requires that the transfer pump and controls are operational.

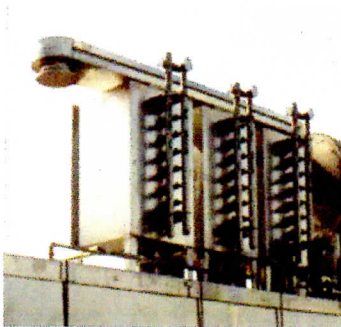

WATER VAPOR RECOVERY CONDENSER

Condenser will recover the water vapor coming off the evaporator. Each application is individually assessed to determine correct type of condenser based upon flow rate off the evaporator and the availability of cooling medium for the condenser. The water may then be recycled within your facility. Requires cooling medium and may increase your operational costs. We will help you closely assess your needs for this option.

REDUNDANT (BACK-UP) LEVEL CONTROLS

Secondary high and low level control assembly, to be installed as a back-up to the primary high/low level controls. Back-up assembly may be either the same type as the primary (float actuated microswitches) conductivity type or frequency shift sensors.

TANK FLUID TEMPERATURE MONITOR/CONTROLLER

Monitors and indicates on temperature of fluid in evaporator tank. This sensor is connected to control circuitry to monitor and control the temperature of the fluid in the evaporator tank. It also functions to shut down the unit if elevated temperature conditions exist due to concentration of fluid other tank water.

INSTALLATION

Installation by factory service technicians or local authorized contractors.

MISCELLANEOUS

Modification of standard equipment for special processes.

**LAKEVIEW ENGINEERED
PRODUCTS INC**

tel: 260-432-3479

fax: 260-432-6239